

RIVER

chaise longue

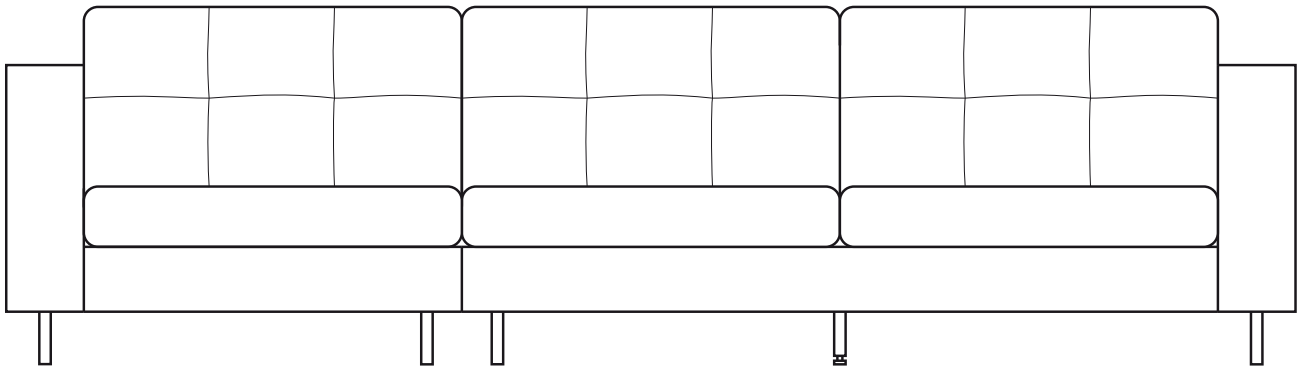

- MOUNTING INSTRUCTIONS -

NL: Tip bij harde vloeren: Plaats viltglijders onder de poten. Dit voorkomt beschadiging aan harde vloeren.

UK: Tip for hard floors: Place felt glides under the legs. This prevents damage to hard floors.

DE: Tipp für harte Böden: Ort Filzgleiter unter den Beinen. Dies verhindert Schäden an harten Böden.

FR: Conseil pour les sols durs : Placez des patins en feutre sous les jambes. Cela évite d'endommager les sols durs.

RIVER

chaise longue

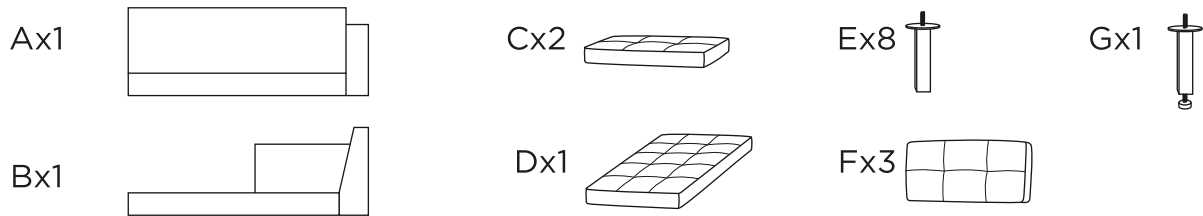

1

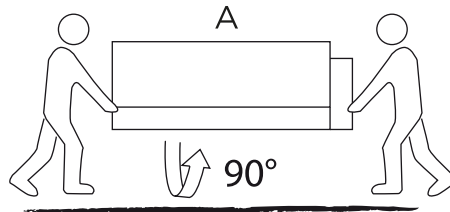

2

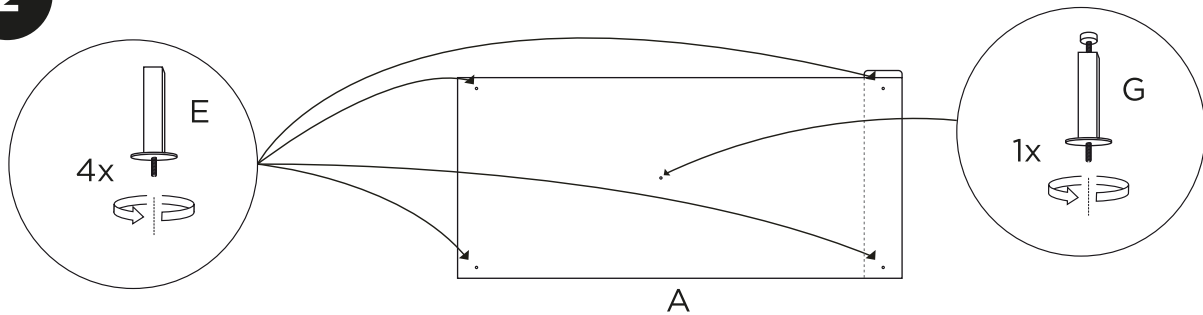

3

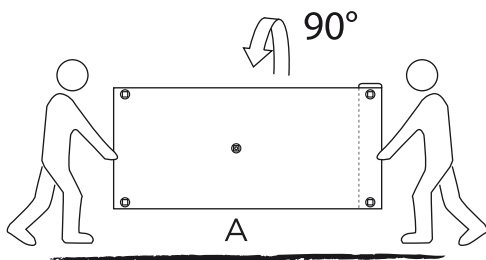

4

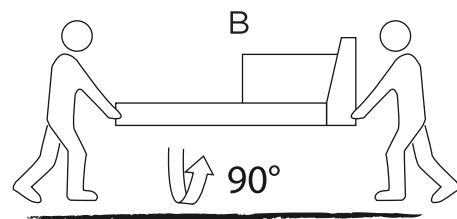

RIVER

chaise longue

5

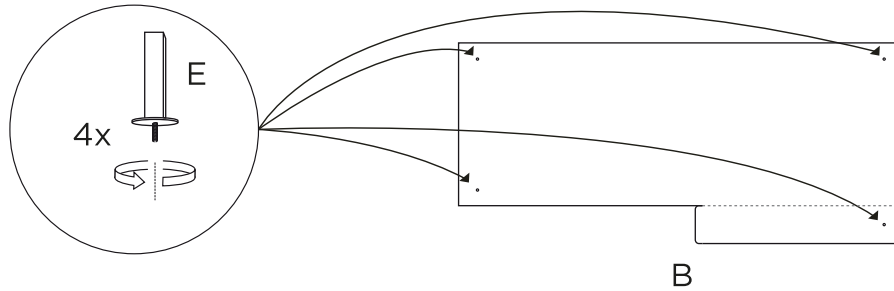

6

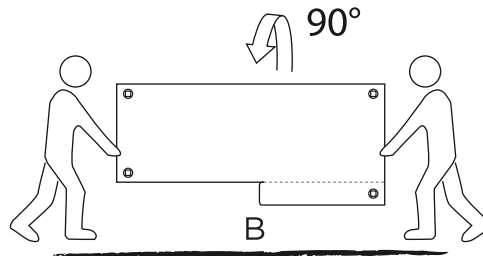

7

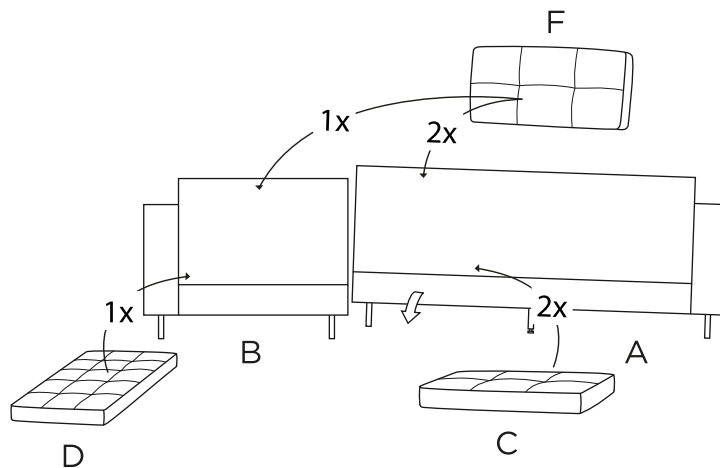

8

